

by DR. GEORGE ONODA

Faster Than A Speeding Bullet?

How fast does the cue ball really travel on a typical break shot?

"HE'S GOING TO knock this ball in at 100 miles per hour....," whispered an ESPN announcer during a televised 9-ball match.

No, the announcer wasn't Joe Isuzu. But, the inference that the cue ball can travel 100 MPH made me curious. Just how fast *does* a professional pool player propel the cue ball on a 9-ball break shot?

I asked some of my pool playing friends, and their guesses ranged from speeds of 50 to 150 miles per hour. Since I had never seen this actual speed reported, I set off to make such measurements.

Video tapes are a rich resource of top professional players in action. With modern technology, it is now possible to analyze these tapes in great detail, using slow motion and frame-by-frame stop action. The time between each frame is one-thirtieth seconds.

The average speed of a ball between two points can be measured from a video tape by knowing the distance traveled and measuring the time taken to travel this distance. Since the dimensions of a table are fairly standardized, the distance between the starting cue ball position and the loot spot where the one ball lies can be easily determined. For example, if the cue ball is placed on the head string, one diamond to the right of the head spot, the distance to the foot spot is typically 53 inches.

The time of travel is obtained from the number of video frames taken from beginning to end. The position of the cue ball in each frame is marked as a dot directly on the video screen. The result is a series of dots along the path. The spacing of the dots in the middle of the path are measured. From this we can determine the total number of frames from the beginning to the end. The time from start to finish is equal to the number of frames times one-thirtieth second. Dividing this into the total distance gives the average speed of the ball in inches per second. This is converted to miles per hour. The measurements are accurate to around plus or minus one-quarter miles per hour.

To be certain that the frame counting method gives the right answer, spot checks were made using an entirely different technique. Here I used the sounds

made when the cue hits the cue ball and when the cue ball hits the rack. With a special oscilloscope, which plots the sound intensity versus time, the time of travel (from one sound impulse to the next) could be accurately measured. It was found that this sound method and the frame counting method gave the same results.

These methods measure the average speed of the cue ball. Because the cue ball actually slows down gradually, the initial speed is slightly higher and the final speed is slightly lower than the average speed. But since the speed only diminishes by a few percent, the average speed serves adequately as a measure of the cue ball speed in a break shot.

I analyzed video tapes of some of the matches in the 1986 Resorts International tournament, and the 1987 Brunswick 9-Ball Team Challenge. (Players involved in the tapes included Mike Sigel, Jim Rempe, Allen Hopkins, Steve Mizerak, Nick Varner and Jose Garcia.) The speed of break shots ranged from 22 to 26 MPH, the average being 24 MPH. The top speed of 26 MPH was recorded for several break shots by Mike Sigel. At this speed, the cue ball reached the one ball in 0.12 seconds.

The speeds of break shots in several women professionals were also measured, using a tape of the Brunswick Team Challenge. In one break shot Jean

Balukas propelled the ball at 22 MPH. Ewa Mataya, Belinda Bearden and Loree Jon Jones typically had speeds between 18 and 21 MPH. From this small sampling, the women's speed were on the average around 20 MPH, which is about 83 percent of the average for the men.

The three or four MPH variations in break shot speeds within players of the same sex might account in part for why some players have better break shots than others. But the tapes reveal that success, where a ball is made, was not strongly correlated with speed. Accuracy was equally important, which meant hitting the one ball in the right place and with the proper English. Often in successful break shots, the cue ball was observed to move about less after hitting the rack than with the unsuccessful shots, indicating that more of its energy has been transferred to the object balls.

In any event, the surprising truth is now revealed. The top speed that a professional propels a cue ball is around 26 miles per hour. Sorry to say that it is not 100 miles per hour, which is the top speed for throwing a baseball. While this may damage egos, take comfort in the fact that the cue ball weighs twice that of a baseball.

Dr. George Onoda is a research scientist at IBM's Research Division, as well as an avid pool and billiard player.

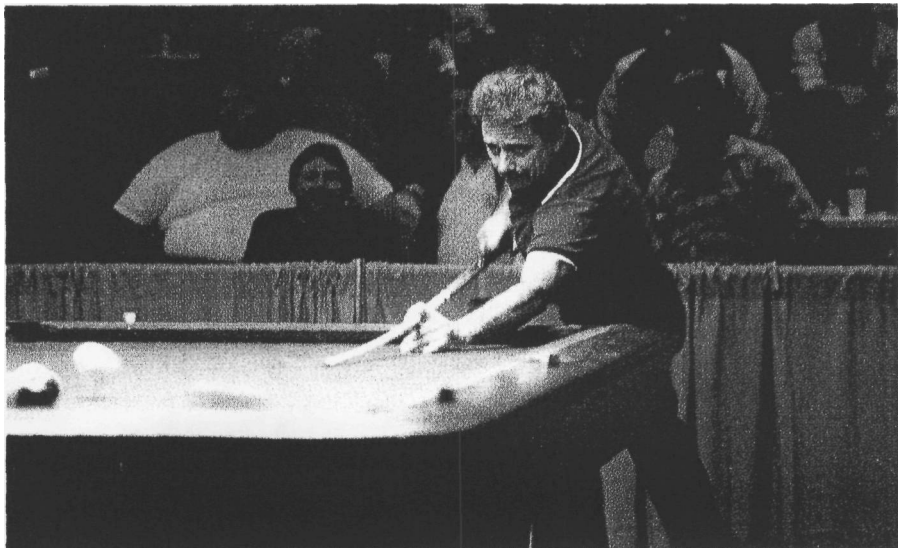

The truth is finally out: Break shots by pros like Danny DiLiberto (above), travel around 25 MPH.

Perfect Draw?

Test your draw shot against the best.

by DR. GEORGE Y. ONODA

STROKING THE BALL as low as possible is like sliding a coin to the edge of a table. The best and the worst differ by a gnat's eyelash. In pool, you either get a great draw or you miscue. Few players chance cutting it too close. But the closer you approach the brink, the better is the quality of your draw shot.

How low do you strike the cue ball? This cannot be determined from the usual draw test, where you measure how far a ball is drawn back in a head-on shot with an object ball. The draw distance depends not only on how low you hit the ball, but also on the force you apply and on the speed of the cloth. To reveal how low the cue ball is being struck, I have developed a method that you can easily carry out on a pool table.

The setup for the method is illustrated in Fig. 1 (a regulation pool table is assumed). An object ball is placed 4% inches from the foot spot in the direction of the foot rail. Applying draw to the cue ball, the object ball is shot into the upper-right corner pocket. The cue ball is placed where the aiming direction is across the table, parallel to the foot rail. The cue ball must be as close as possible to the object ball, without interfering with the stroke, so that the least amount of back spin is lost when the object ball is reached.

When the cue ball caroms off the object ball (Fig. 1), it initially travels along the tangent line (a line perpendicular to the direction that the object ball travels). Then the back spin curves the ball to the left, toward the head rail. After curving, the ball rolls along a straight path, or track.

The direction of this final track determines the quality of the draw. The closer this direction is to being parallel to the long rail, the lower the cue ball has been hit below center during the stroke. Altering the speed of the shot causes the length of the curve to change and the final track to shift. However, if the cue ball is struck the same distance below center, the direc-

tion of the final track remains the same irrespective of speed (see Fig. 2). The speed of the cloth also shifts the track but does not change its direction. This method works well with soft and medium strokes. If the ball is hit too hard, it will strike the long rail while it is still curving, and the final direction is not achieved.

This method is based on theory (the physics of pool). Let us suppose for sake of argument that the lowest a cue ball can be struck safely is around two-fifths the distance from the ball's center to the table surface. For the present, we will call this the perfect draw. Theory predicts that when the object ball is cut 39 degrees from the forward

direction, the final track of the cue ball stroked with perfect draw and a horizontal cue will be perpendicular to the forward direction. In our setup, the object ball goes off at 39 degrees if sunk in the corner pocket. Since the cue ball is aimed parallel to the short rail, its final track ends up parallel to the long rail when a perfect draw shot is achieved.

Thanks to friends at the Jack and Jill Cue Lounge (Brewster, N.Y.), this method has been tested with players of varying abilities. The best players could sometimes, but not always, bring the ball parallel to the long direction. Less-skilled players had inclined tracks where the cue ball hit the long rail

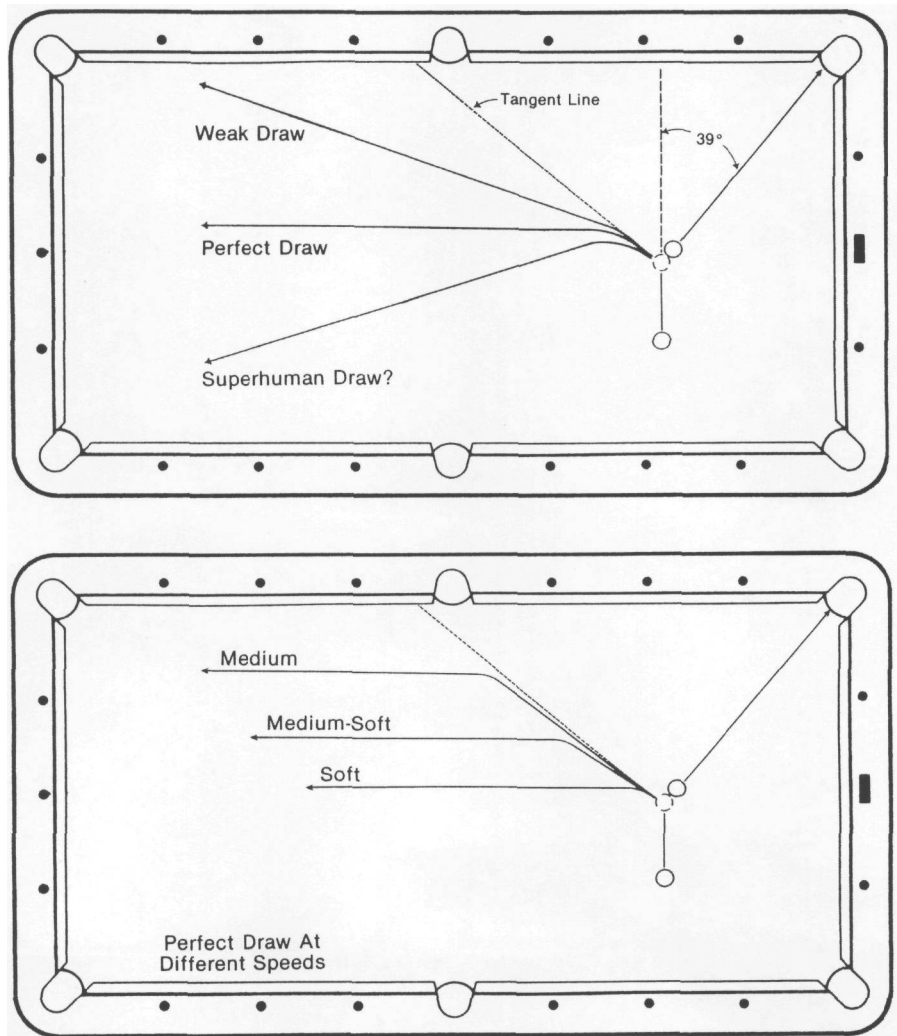

before reaching the head rail. Interestingly, one player with an exceptional stroke seemed to be able to exceed the parallel limit by a few degrees. This might mean that the ball was struck lower than what we assumed for perfect draw. However, there is a little slop in our test, because the width of the pocket is more than twice the diameter of the ball. It is possible to cheat the pocket by about two degrees, which could explain how the parallel limit was exceeded slightly.

With this method, it is possible to test the truth about several assertions. One is that the cue ball can be hit significantly below the two-fifths point. If the ball could be struck half the distance from the center to the bottom, then the final track would exceed the "parallel limit" by around 12 degrees. This would be a shift sideways of almost one diamond for a forward travel of four diamonds, which would be very noticeable. There is also the question as to whether a partially inclined cue aids in increasing draw. In our setup, the cue must be inclined (slightly elevated) by at least five degrees because of the interference of the rail. If this causes an increase in the amount of draw compared with a horizontal cue, then increasing it even more (e.g. 20 degrees) should have a pronounced effect and cause the track course to exceed the parallel limit significantly. (A masse shot with a near-vertical cue is another matter, which we do not include in this discussion.)

So the question is, can the parallel limit of the track be exceeded significantly by any means other than a strong masse shot? Is it possible to cause the track to point toward the bottom-left corner in Fig. 1, for example? If any reader can achieve this seemingly superhuman draw, let me know, as it will give us new insights on the physics of draw. Please be reminded that the test is valid only if: 1. The balls are in the right position; 2. Your aim is parallel to the short rail; and 3. The object ball is sunk in the corner pocket. It is helpful to have someone watch to be certain that you are aiming parallel to the short rail as you shoot.

Dr. George Onoda is a research scientist at IBM's Research Division, as well as an avid pool and billiard player.

by Dr. George Onoda

Know These Winning Caroms

Win with a dead carom off a spotted object ball.

CONSIDER THE SITUATION in Diagram 1 from a 9-ball game. Your opponent made the 5 ball, but has scratched. The 5 is on the foot spot and you have ball-in-hand. The 9 ball is sitting in the jaws of the far, corner pocket. You cannot shoot the 5 into the 9. Nor can you make the 5 ball in a pocket to start a run. Your best hope is either to play a safety or to carom the cue ball off the 5 and into the 9 for an immediate win.

Many players will pass up the carom shot because the opponent may run the table if it is missed. It is easy to play an effective safety instead, giving you a chance to run the table or knock the 9 in on your next turn. But you might not be so lucky; your opponent may play a great kick shot, leaving you with nothing.

You probably would not hesitate playing the carom immediately if it were a high-percentage shot. How would you play the carom? Would you put the cue ball at point N and hit the 5 ball very thin? This is a delicate shot, with little margin for error in aiming the ball; you would be doing well making this shot 50 percent of the time. Would you instead put the cue ball near point P and carom with draw or stun action? This is an even more difficult carom to execute reliably, for the path depends on three variables (the angle of the cue, the amount of back spin, and the speed).

So, if the caroms from N and P are not reliable enough for this situation, is there a better carom shot? Definitely! In fact, there is a carom that you can make better than 90 percent of the time. It involves a half-ball hit on the 5 ball, with soft, rolling action, both of which are easy to execute. But you have to know how to set it up.

First, why a rolling, half-ball hit? As discussed in several of Robert Byrne's articles, a soft, rolling, half-ball shot gives a deflection angle for the cue ball that is accurate, reliable and resistant to error. This deflection angle is now

accepted to be 34 degrees. It is also easy to roll a cue ball; you only need to stroke it softly above center. And the aim does not have to be perfect, since a small error does not change the deflection angle significantly.

The above knowledge is of little value unless the cue ball and two object balls are precisely aligned for the 34-degree deflection angle. In most game situations, you have little or no

control over the alignment. But if you have cue ball in hand, you can set up whatever alignment you wish (assuming no interfering balls). In other words, in Diagram 1, there is a place (e.g. Point R) where the cue ball will be properly aligned with the 5 and 9 balls for the easy carom. The only problem is knowing where to place the cue ball.

Diagrams 2, 3 and 4 show how to

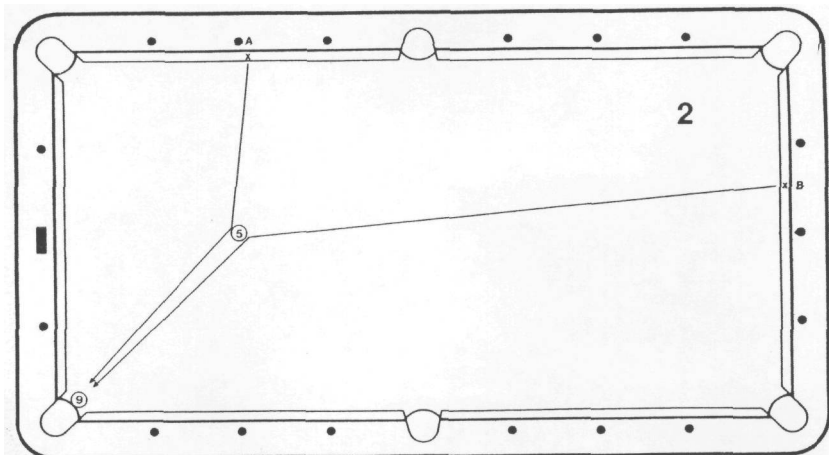
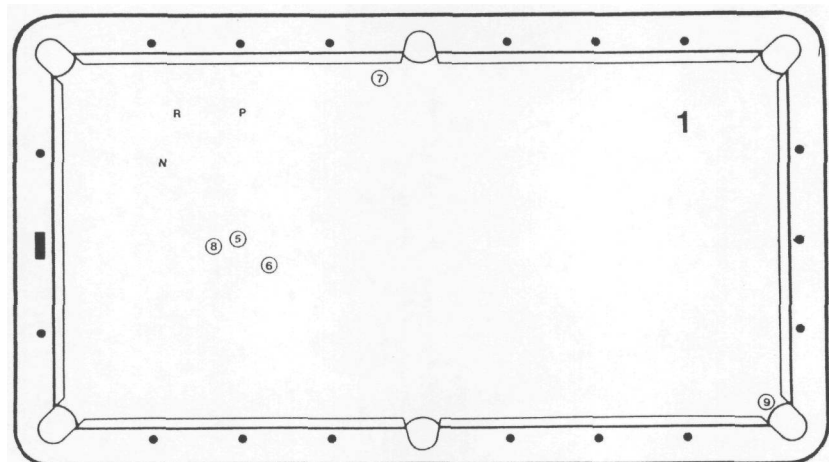

set up the proper alignment for caroms leading to different pockets on the table. These are for pockets on one side of the table. For those on the other side, imagine looking at the diagrams in a mirror. Now each pocket in the three diagrams can be reached in two ways, from one side or the other of the object ball. Critical points along the rails are identified. Once an appropriate critical point is known, a critical line is drawn from it to the edge of the object ball. The cue ball is then placed anywhere along this critical line, the spotted ball is struck with a soft, rolling, half-ball hit on the appropriate side of the object ball, and the cue ball follows the carom line to the 9 ball.

To reach a near corner pocket, as shown in Diagram 2, one critical

point, "A," lies on the opposite long rail, 1 inch past the second diamond. The other critical point, "B," is on the head rail, one-half diamond from the center diamond. This shot from Point B is essentially the shot described on page 112 of *Byrne's Standard Book of Pool & Billiards*. When this book was originally published, the standard 9-ball scratch rule was that the cue ball was in hand behind the head string. Now, with the more popular ball-in-hand anywhere on the table rule, dead caroms to all pockets become possible.

To reach a side pocket, as in Diagram 3, one critical point, "C," lies 1 inch from the center diamond on the foot rail, in a direction away from the side pocket. The other point, "D," lies 1 inch from the second diamond

on the opposite long rail, in the direction toward the foot rail.

To reach a far corner pocket, Diagram 4, one critical point, "E," lies 1 inch from the first diamond on the foot rail. The second point, "F," lies on the opposite long rail, halfway from the first diamond and the corner pocket.

These critical points are not hard to remember, since they are either 1 inch from a diamond, or are halfway between two diamonds. Their locations should be checked for your table, as variations can occur with different tables. The necessary adjustments can be determined quickly by trial and error.

I know that some readers may doubt the reliability of these shots. But if you are careful in aligning the cue ball along the critical line, if you shoot a fairly accurate, half-ball hit, and if you shoot softly, it's almost impossible to miss. You will be a believer if you try it. With a few minutes of practice, you can make these shots at least nine out of 10 times.

The carom is somewhat more difficult if the 9 ball is not squarely lined up in the pocket. A compensation is made by moving the cue ball off the critical line a small amount. To visualize what is necessary, imagine that the critical line and the carom line are joined together as a stick, bent 34 degrees at the foot spot and nailed to the foot spot about which it could rotate. If we move the near end of the stick to the left, the far end moves to the right, and vice versa. Thus, if the 9 ball is misaligned to the left of the carom line, the cue ball must be moved to the right of the critical line. The amount moved depends on how far the 9 ball and the cue ball are from the foot spot. The further the 9 ball, the less the cue ball has to be shifted. Judging these shifts requires practice, but can be quickly learned.

Opportunities such as that depicted in Diagram 1 do not arise often. But neither do dead-on, frozen combinations for the 9 ball. Nevertheless, if you recognize and know how to take advantage of such gifts, you will win more games. A game-winning carom might even break your opponent's concentration.

Dr. George Onoda is a research scientist at IBM's Research Division, as well as an avid pool and billiard player.

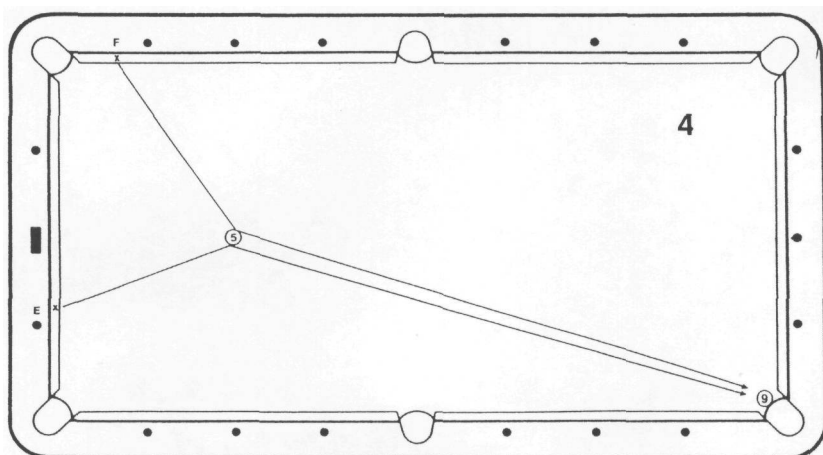
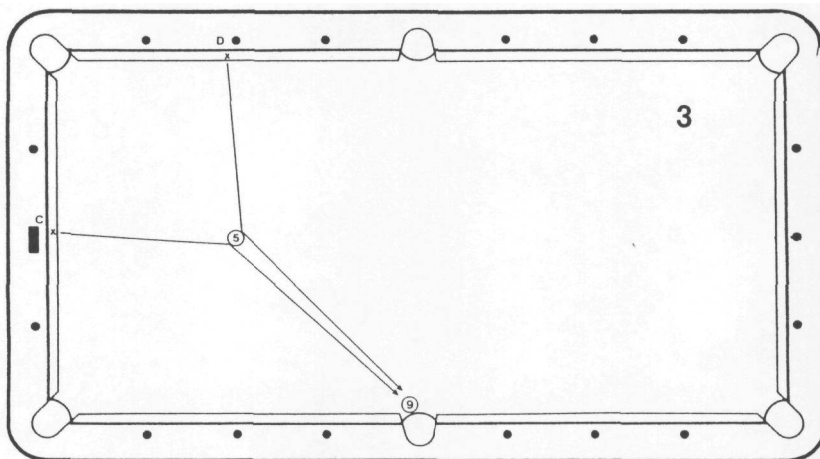

by Dr. George Onoda

Analyzing The 9-Ball Break

Useful insights on where balls travel.

THE TYPICAL 9-BALL break shot is a slam-bang explosion that sends balls rushing in every conceivable direction at break-neck speeds. Normally, players and spectators alike haven't a clue as to the carnage until the balls have stopped rolling. But are there important trends in the path of various balls that we can use to our advantage?

To seek some answers, I began a detailed, systematic analysis of tournament video tapes, using slow motion and stop action.

Before getting into the findings of this study, first a few words about notations, definitions and assumptions. Ball positions in a rack will be denoted by the letters "A" through "I" (Diagram 1). "Collisions" will refer to contact between two object balls after the initial rapid impacts occurring within the rack, "Directly" pocketed balls will be those reaching the pocket without collisions and will include those made by bank shots. The "top" of the table is the foot end, while the "bottom" of the table is the head end. Pockets are identified by their positions ("left-top," "left-bottom," etc.) The forward direction is toward the top, the backward direction is toward the bottom. The cue ball is assumed to be shot from the right side of the table and directly (full) at the 1 ball.

The relative speeds and directions of the object balls leaving the rack area were observed in hundreds of break shots. Interestingly, a number of systematic trends were seen, as summarized in Diagram 2. The fans in the diagram, emanating from the centers of each object ball, designate relative speeds and directions. The longer the fan, the greater is the relative speed. The spread of the fan indicates the range of directions that were observed.

As with player introductions, let's meet the balls in a 9-ball rack:

Ball "A" (always the 1 ball) moves to the left and back with slow to moderate speed. Its exact path depends on where the I ball is hit by the cue ball. If hit toward the center,

the 1 ball moves in the direction of the left-bottom pocket. If hit more on the right side, the 1 ball moves more toward the left-side pocket. The 1 ball can be directly pocketed in one of three pockets. It can fall in the left-side or left-bottom pocket, or be banked into the right-bottom pocket. If not pocketed or diverted by a collision, the 1 ball usually ends up at the bottom half of the table.

Ball "B" travels along a narrow

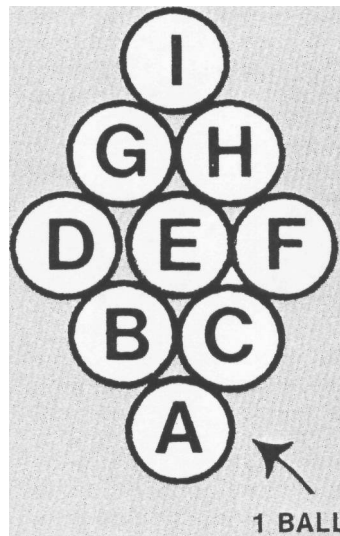

path, to the left and somewhat back. In some instances, it banks into the right-side pocket. Otherwise, it tends to remain in the middle part of the table, unless kicked away.

Ball "C" travels weakly to the right, either sideways or forward. Because of its slow speed, it does not reach the top-corner pocket and tends to remain in the top-right part of the table, unless kicked away.

Ball "D" is the fastest ball leaving the rack. It was never observed to travel directly into the top-left pocket; rather, it strikes the long rail, within one diamond of the pocket.

Ball "E" (the 9-ball) is probably the most unpredictable ball. It moves slowly in a generally forward direction, to the left and sometimes to the

right. Occasionally it manages to reach the left-corner pocket; rarely does it reach the right-corner pocket. When the 9-ball is made on the break, it is often kicked in by another ball.

Ball "F" is the second fastest ball to leave the rack, traveling toward the right-top corner. It either strikes the long rail or falls directly into the top-right pocket.

Ball "G" moves weakly forward and to the left. If not hit by another ball, it often remains near the top rail and the left side. This ball is not pocketed unless kicked by another ball.

Ball "H" travels forward and to the right with moderate speed. If unobstructed, it banks off the top rail and moves toward the right-center area of the table. It can occasionally be sunk in the right-side pocket.

Ball "I", the third fastest ball leaving the rack, banks off the top rail. The further the 1 ball is truck on the right side, the more "I" travels to the right. If the "I" ball escapes collisions, it moves to the right-bottom end of the table, where it could fall in the corner pocket.

Most top players break from the side, within one diamond of the long rail. This does not increase the chances of making ball "F," the most frequently pocketed ball. Neither is there conclusive evidence that it increases the chances of making the 9 ball. However, it most definitely increases the chances of making the 1 ball in the left-side pocket (the second most frequently pocketed shot). The 1 ball moves toward the side pocket if it is struck at the appropriate point on the right side of the cue ball. This is the only ball where a player has a significant opportunity to influence the outcome. Also, breaking from the side causes ball "I" to bank toward the right, increasing its chances of falling in the bottom-right corner.

The majority of shots made on the break are due to directly pocketed balls, while collisions account for the rest. As expected, the fast-moving balls (D, F and I) account for most of

the lucky collisions. Balls D and F bank around the top corners and collide with slower balls, such as G and H. Ball I banks off the top rail and kicks balls such as H and C. As the results of these collisions depend on minute differences in timing and path, little prediction is possible.

A widely-held strategy is to try and leave the cue ball in the center of the table after the break because this increases the chances of having a shot at the 1 ball. Since the analysis shows that the 1 ball usually ends up somewhere in the bottom half of the table, the soundness of this logic is supported.

How can this knowledge affect a game?

Well, when you rack balls, do you pay any attention to how you arrange them? Several strategies have been brought to my attention by colleagues Robert Byrne, George Cleveland and Steve Priest, among others. Suppose you want to increase the chances that the 2 ball will lie near the top rail after the break, so as to make the transition from the 1 ball to the 2 ball more difficult for your opponent. The analysis indicates that position G is most likely to produce this result. If you also want the 3 ball to travel to the bottom end of the table, positions I or B seem favorable.

The placement of balls could also affect a handicap game. If you don't want your ball to be sunk by your opponent, positions C and G appear safest. If your opponent changes the side from which he breaks, these positions become B and H, both still relatively safe. In situations where it

is favorable to you if your opponent sinks a certain ball, place it at F.

Most players have their own strategies in breaking balls. Hopefully, the information I have provided will help assess these strategies. I apologize to those readers hoping I

would reveal how to make the 9 ball on the break.

Even if I knew that secret, would I give it out for free?

Dr. George Onoda is a research scientist at IBM's Research Division, as well as an avid pool and billiard player.

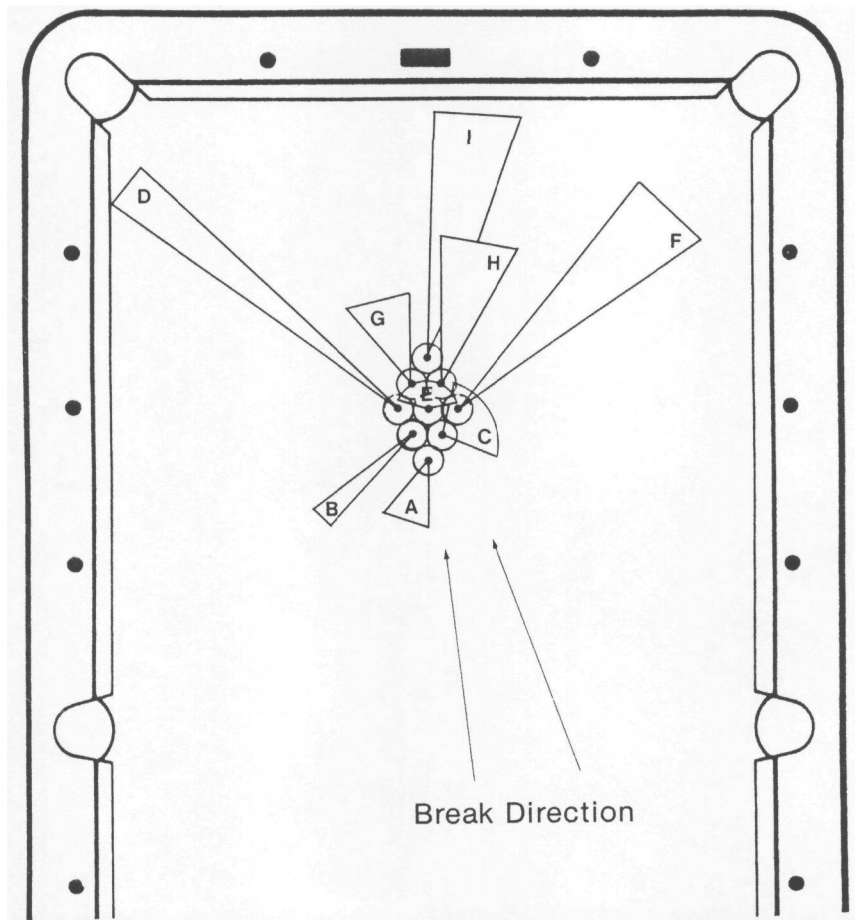

by Dr. George Onoda

Seeing The Point Of A Frozen Kiss Shot

A sighting method for visualizing the object ball's path.

IN MOST WALKS of life, a cold kiss is a truly underwhelming experience.

But pool is very special, and few aspects of the game are as delicious to behold as a "cold" kiss shot ... at least, to the accomplished player. Let's see what *you* can do to improve your ability to determine whether kiss shots are really "on" or "off."

Diagram 1 shows frozen balls A and B. Line A-B is drawn through their centers. If ball A is struck by a cue ball as shown, its path of travel will be 90 degrees (or perpendicular) to line A-B. (This relates closely to the concept discussed recently by almost all *Billiards Digest* instructional writers: on all cut shots, a cue ball struck with stop shot action will deflect 90 degrees from the path of the object ball.)

In any case, it's obvious that if you expect to pocket ball A, or any other kiss shot, you'll have to visualize that 90° direction accurately. Some players appear to do this with no conscious effort at all. One conscious technique is to point at the A-B line with your cue, and extend your hand across it (as though making an oversize plus sign). If your hand points to a pocket, you're in business. Another is to stand at the pocket you want for the shot, and visualize an imaginary line (or place your cue along it) from the center of the pocket to the contact point between balls A and B. If that line and the A-B line seem perpendicular, or if the two balls seem to be the same distance from the pocket, that kiss shot is "on."

If you find these visualizations difficult or unreliable, try this "point" method: bend down and sight between balls A and B in the general direction of the pocket (Diagram 2). The "V" between the balls acts as a rifle sight. Move your eyes to the left and right, looking at the contact point. When that point looks sharp to you (Diagram 2A), you're sighting along the 90-degree line. If your line of sight is off, the two balls will appear to overlap (Diagram 2B). It should be obvious that you do *nothing* about shooting ball A until you're correctly sighted.

Notice, in Diagram 1, that it is the *edge* of ball A - not the center - which follows the 90-degree sight line. The path of the center of ball A is shifted by half the width of the ball. So your

sighted line should correctly point to a pocket's edge, not its center.

Judging kiss shots is a matter of good lighting, fairly keen eyesight, and practice. Experiment with the techniques described here and see which works best for you; one of them is almost certain to.

One important word of caution: in Diagram 1, note the direction of the cue ball. *In order to move ball A 90 degrees from the A-B line, the cue ball must make contact well off to the side of the A-B line.* If ball A is struck too full, relative to the A-B line, you'll get markedly different results. The path of Ball A deviates forward from the 90-degree line. Just why and how will be discussed in a future article.

Dr. George Onoda is a research scientist at IBM, and an avid pool and billiard player.

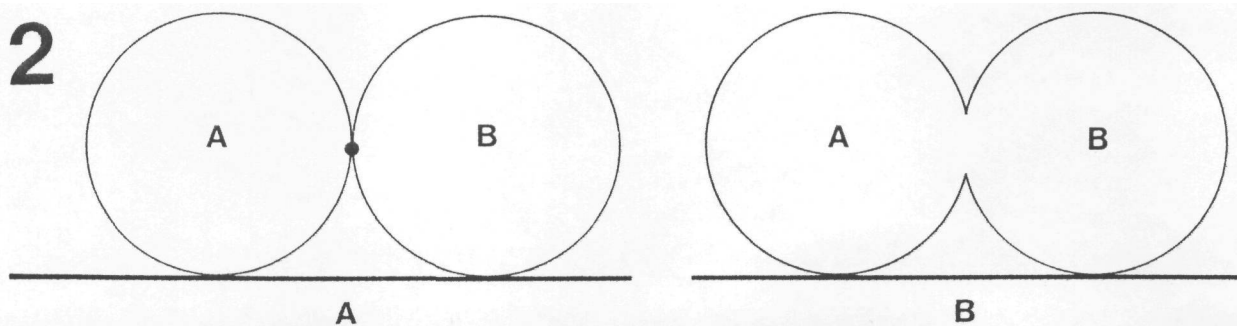
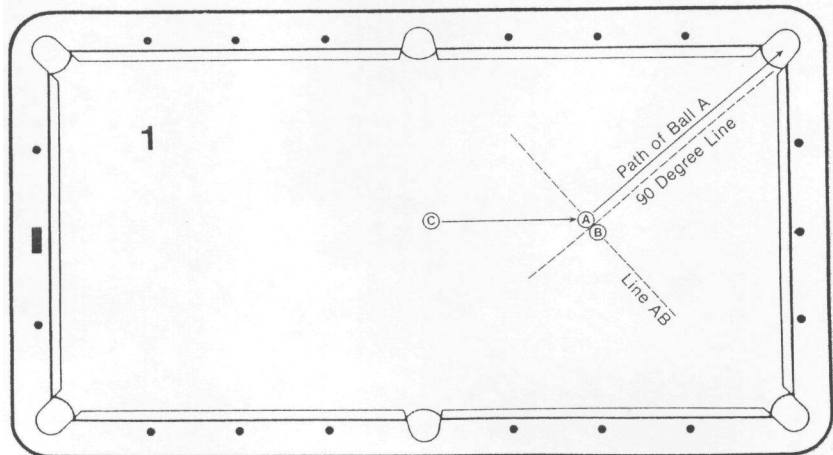



by Dr. George Onoda

Play For Show, Or Play For Dough

Winning 9-ball games with safety play.

IN MOST 9-BALL tournaments, you have two ways to win a game: you sink the 9-ball legally, or your opponent "scratches-out" (that is, scratches three times in a row). In professional play, almost all games are won by making the 9-ball. Safeties are used for various tactical reasons, but they are seldom used to force a scratch-out. In amateur play, on the other hand, there are more opportunities to win games by forcing a scratch-out. Here's why this is so, along with some examples of winning with safety plays in amateur competition.

Forcing a scratch-out on a professional is far more difficult than on an amateur. A pro seldom scratches on his own, while an amateur does so occasionally and sometimes frequently. A pro can usually "kick" successfully at a ball; amateurs have less success at that. It is especially unlikely that a pro would miss a kick two or three times in a row, while many amateurs are quite capable of such misplays.

So if you compete at the amateur level, you should not focus all your attention on running out, or on sinking the 9-ball on a combination or kiss shot. You should also consider forcing a scratch-out, particularly if your opponent has just scratched. You should realistically assess the chances of sinking the 9-ball versus the chances of scratching-out your opponent. Your decision rests upon how the balls lie upon the table.

Your best chance to play for a run-out usually comes up when the balls are spread apart. But when balls are clustered, as they often tend to be near the beginning of a game, the run-out may be more difficult, and safety play considerably easier. A cluster can be used to your great advantage as a barrier, when you shoot the cue ball to one side and the object ball to the other, leaving no clear shot.

When using a cluster as a barrier in this way, you want to make sure that it is difficult for your opponent to kick at the object ball. If he can get to the

object ball rather easily by banking the cue ball, you've gained very little except to keep him from pocketing, and he might get lucky and leave you safe. In planning your safety shot, imagine where you intend to place the cue ball and object ball with the shot, and then put yourself in your opponent's place. If you've left him where it's impossible, or at least very difficult, for him to see a way to hit the object ball, you've made a good choice.

Now for the most important aspect of winning safety play. Remember, you need to force two more scratches in a row if your opponent has just

scratched, three if he hasn't. So when you are planning your first safety shot, you must figure where the object ball will end up after the shot; it is not enough to merely hide it. *The object ball must lie where it will be easy for you to execute the second safety shot.* If you don't have that kind of advantageous lie, rethink your first safety shot until you find a strategy that gives you a better chance of forcing two consecutive scratches.

Suppose the balls lie as in Diagram 1. Your opponent has scratched, and you have ball in hand. Your chances of running out are not very good —

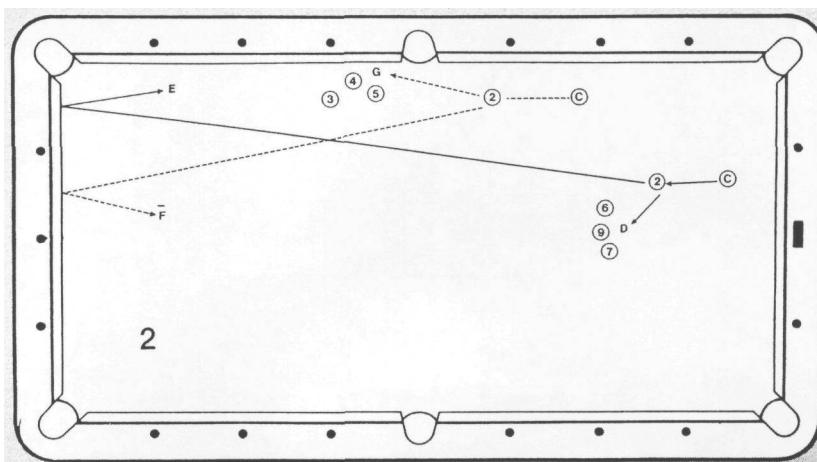
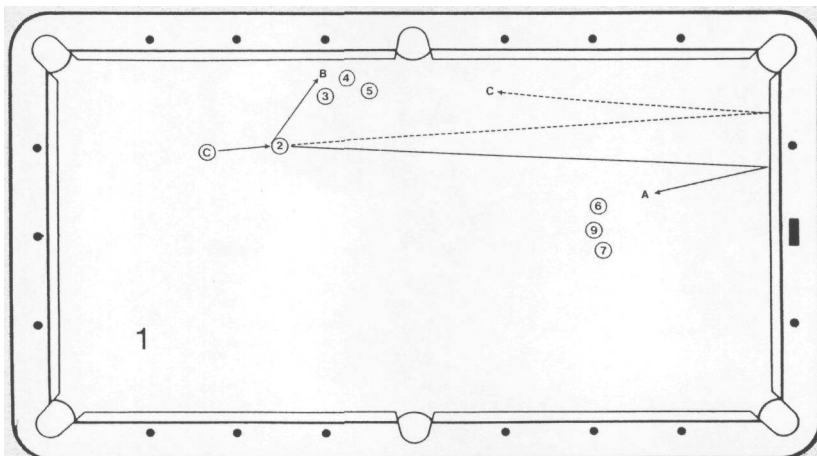

but notice how the 3-, 4- and 5-balls are clustered. An effective strategy here would be to place the cue ball as shown, and shoot the 2-ball to A, leaving the cue ball at B. This leaves a difficult kick shot for your opponent. At the same time, the 2-ball has been moved near another cluster, where you can execute a second effective safety by shooting the 2-ball to E and leaving the cue ball at D (as in Diagram 2).

You could also use the same cluster for *both* safeties by shooting the 2-ball to C, while putting the cue ball at B (dotted lines in each diagram). After the scratch, the 2-ball is shot to F, leaving the cue ball at G (Diagram 2).

If the 2-ball is not near a cluster to begin with, any nearby ball may serve adequately as the first barrier. For example, if the 3- and 5-balls were removed from Diagram 1, you could still hide the cue ball behind the 4-ball, near point B. While it's more difficult to put the cue ball behind one object ball instead of a three-ball cluster, this shot can be mastered with practice.

Finally, I realize that some readers will not like the strategy of winning with safeties. Obviously it's more spectacular and satisfying to execute a tough run-out. And if you know you can out shoot your opponent, why bother with a scratch-out strategy at all? For one simple reason: there is considerable luck in 9-ball. If you fail to run the table, your opponent might slop in the 9-ball on his next shot. So you'd be wiser to go for the win immediately by whatever means possible. A game you win through defensive play counts for just as much as one you win by running all the balls.

Some opponents might consider it poor sportsmanship, even less "manly", to win a game by forcing a scratch-out. But remember, you aren't breaking any rules; what you're doing, in fact, is taking advantage of one. You're playing smart. You're playing for "dough," and not for "show."

Dr. George Onoda is a research scientist at IBM, and an avid pool and billiard player.



by Dr. George Onoda

Avoiding Miscues On Draw Shots

Believe it or not, most miscues on draw shots are caused by hitting the cloth before the ball.

DRAW SHOTS ARE often difficult for novices and some intermediate players. A mediocre draw shot results from not striking the ball low enough. But when a lower strike is attempted, the dreaded miscue frequently occurs, especially on more forceful strokes. Such miscues are sometimes attributed to a poorly chalked cue, or by the ball's being struck too low. But my studies reveal that the prevalent cause for a miscue is that the cue tip strikes the table surface before striking the ball. I'll show you how I came to this conclusion, using simple experiments that you can try yourself to confirm my results.

The first experiment determines how far off-center a ball can be struck without a miscue, using a well-chalked cue. Although we are primarily interested in how low a ball can be struck below center, it is easier to determine the maximum off-center strike with *side* English instead, which should be the same as for the maximum distance *below* center. A useful fact is that the width of the stripe on a striped pool ball is exactly half the diameter of the ball (Fig. 1). When a striped ball is used as the cue ball, the edge of the stripe itself serves as a useful reference point. With the stripe facing you (Fig. 1), a strike within the striped area is off-center by less than half the radius of the ball. A strike in the white area is more than halfway from the center to the edge of the ball. This experiment involves the following steps: Remove all traces of chalk marks from the ball. Align the ball so that it appears as in Fig. 1. Apply a liberal amount of chalk to your tip. Strike the ball to the left of center. Note where the new chalk mark appears on the ball. Repeat these steps many times, while varying the strike distance from the center. Keep track of where the chalk mark appears after a successful draw shot and after a miscue.

I have found that the maximum off-center distance that a ball can be reliably struck without a miscue is half

the distance from the center to the edge of the ball (point A in Fig. 1). Miscues do not occur if the ball is struck within the striped zone; but they almost always occur when the ball is struck in the white area. Try this experiment to see if your results are the same as mine.

Some players believe that the cue ball can be struck beyond this halfway point. When the true contact point lies at the edge of the stripe, the center line of the cue points to the white area.

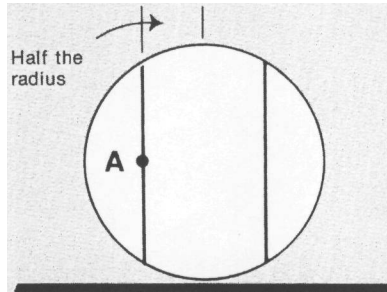

The edge of the stripe on a ball is halfway between the center and edge of the ball. Point A is the maximum off-center strike point without incurring a miscue.

This gives the mistaken impression that the ball is being struck outside the striped area.

The next experiment determines why miscues occur in draw shots, assuming the tip is well-chalked. Clean a striped ball, removing all chalk marks. Align the stripe horizontally, as in Fig. 2. Slide the edge of a white sheet of paper against the bottom of the ball, with the paper nearest you. If your tip contacts the ball before hitting the ball, no chalk mark will appear on the paper. If the table is struck before the ball, a telltale mark will appear on the paper. Try to strike the ball at the lower edge of the stripe, with a level cue. When a miscue occurs, check the paper and the ball for chalk marks. If the miscue occurred without a mark on the paper, see if the chalk mark on the ball is below the striped zone, which would indicate that the miscue occurred because the ball was struck too low. If there is a

mark on the paper, assuming your cue was level or close to it, then the miscue occurred because the table surface was struck first.

When I carried out this experiment with players who miscued frequently on draw shots, I found that in most cases, their miscues were caused by the tips' striking the table first. Only in a few instances could the miscues be attributed to hitting the ball too low, instead of hitting the table first.

These results led me to understand why it is so difficult to strike the halfway point between the center and bottom edge of the ball. The clearance between the bottom edge of the cue and the table surface is quite small. With a cue tip of 13 mm diameter, and a curvature of a nickel, a strike at the bottom edge of the stripe has a clearance of only a few millimeters (1/16 to 1/8 inch) between the bottom of the tip and the table surface (Fig. 2). A cue tip that strays downward by a few millimeters during the stroke would strike the table first. The tip would rebound from the table and strike the ball with an upward force component, causing the ball to jump erratically. This effect can be seen by intentionally striking the table just before the ball.

From what we've just learned, three methods for preventing miscues on draw shots become evident: 1) Use a slightly inclined cue; 2) Use a cue with a smaller tip; or 3) Develop a more accurate stroke. For most cases, the third is the best solution, since the first two have other drawbacks on many shots; let's examine those drawbacks next.

An inclined cue increases the distance between the bottom of the cue tip and the surface of the table, as seen in Fig. 3. This reduces the chance of striking the table first. Drawing with an inclined cue is sometimes necessary, as when another ball must be shot over, or when the cue ball is near a rail. For the majority of shots, though, a more level cue has advantages over an inclined cue. With an inclined cue,

DOCTOR'S ORDERS

it is more difficult to aim; it is likely that the ball will jump (as in a jump shot); and it is inevitable that the ball will curve if struck to the left or right of center.

The size of the cue tip is a factor in the difficulty of striking the halfway point on the ball. A smaller tip increases the distance between the bottom of the tip and the table surface when using draw. The clearance is increased by about 50 percent when switching from a 13 mm cue tip to a 12 mm. But too small a tip wears out more readily. Also, a thin shaft is believed to cause greater squirt (deflection), where a ball struck with left or right English deviates somewhat from the aimed direction. We can now understand why tips are not larger than about 14 mm. If they were, it would be impossible to strike the halfway point below the center of the ball because there would be no clearance for the tip.

In most cases, the best solutions for avoiding miscues are to use as level a cue as possible, and improve the accuracy of your stroke. For optimum draw, the ball should be struck at the halfway point between the center and edge of the ball without striking the table first. This requires an accuracy of less than a few millimeters in the placement of the cue tip on the target spot on the ball. That accuracy is not so easy to accomplish. For example, if you have trouble banking a ball in the long direction of the table so that it comes back to hit your cue tip, it means that you are accidentally strik-

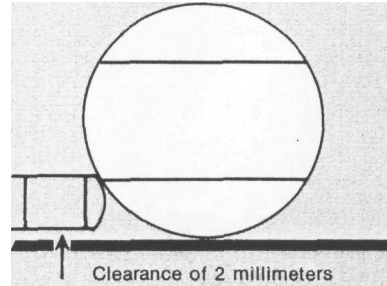

A ball struck halfway between the center and bottom of the ball provides only a few millimeters of clearance between the cue and the table. A miscue occurs if the table is struck first accidentally.

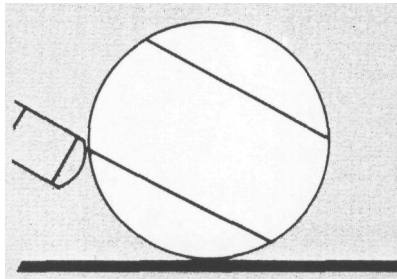

The clearance between the cue tip and table is now much greater. The likelihood of striking the table first is greatly reduced.

ing the ball somewhat to the left or right of center by at least a few millimeters. The same inaccuracy in the downward direction would exceed the clearance dimension of an optimum draw shot, causing the table to be struck before the ball.

To improve the accuracy of your

stroke, seek help from a house pro if possible, explaining what you want to accomplish. Or study your stroke with a video system or a mirror. See if you lower the tip as it approaches the ball. Practice developing a smooth, straight, level stroke with a straight follow-through. Use a short bridge-to-ball distance to minimize the effects of an upward motion of the cue butt during the stroke. Make a snug, closed bridge to help keep the cue in line. At first, concentrate on striking the ball softly at the halfway point between its center and bottom edge, with the cue ball around one foot from the object ball. You might be surprised how much draw you can get even with a soft stroke, if you successfully strike the ball at the halfway point. As you become more proficient with the soft stroke, gradually increase the speed of the stroke until you can execute a strong draw shot without miscuing.

How well you can draw a ball with considerable force is in fact a good measure of the quality of your stroke in general. All the knowledge of how balls react on various shots is of limited value until a good stroke is developed. More attention should be given to improving your stroke before worrying too much about learning the other skills of the game. Emphasize practice exercises; remember that concert pianists began by laboriously practicing fingering drills for many years.

Dr. George Onoda is a research scientist at IBM and an avid pool and billiard player.



by Dr. George Onoda

Coping With Skid

Sometimes the cue ball grabs the object ball and throws it off line. Here's why it happens and what you can do about it.

IT DOESN'T MATTER if you shoot like me or you shoot like Earl Strickland, Nick Varner, Mike Sigel or Allen Hopkins; we are all cursed occasionally by the dreaded "skid" shot. In a skid shot, an object ball that is cut toward a pocket travels in a direction as if it were cut less thin. At the same time, the object ball seems to skid (slide) more than normal. Judging from color commentaries in various taped matches, many top professionals find skid a mystery. Skid only happens occasionally, perhaps once during a long 9-ball set or during a straight pool match. This would amount to around one in 100 to 200 shots (as a rough estimate).

I believe that the skid phenomenon has already been explained correctly by Robert Byrne (*Byrne's Standard*

Book of Pool and Billiards, 1987 Ed., page 129). He calls this phenomenon "cling," but I will stay with "skid" since players seem to use this term frequently. Byrne's theory is that skid occurs when the normal friction between the ball surfaces is increased. The increased friction causes the ball to be thrown in a more forwardly direction than normal in most types of shots. In *Byrne's Treasury of Trick Shots in Pool and Billiards*, pages 152 and 153, he describes several insightful experiments by Robert Jewett and Bill Marshall. When chalk marks were placed at the contact points between two colliding or frozen balls, throw of cut shots was greatly increased. Since chalk increases the friction between two balls, the experiments support Byrne's theory.

One or more chalk marks always exist on a cue ball. The mere act of striking the ball with a chalked cue produces a fresh chalk mark on the ball. Typically, a fresh chalk mark is around a quarter of an inch in width. As the ball moves along the table, a chalk mark becomes duller and smaller with time. But it may take a half dozen shots before a particular chalk mark completely disappears. Therefore, beside the fresh chalk mark produced by a shot, several older and weaker marks are usually present on the surface of the cue ball.

If the contact point of the cue ball with the object ball just happens to coincide with a chalk mark on the cue ball, then enhanced throw can be expected. And if the cue ball has forward roll, a pronounced transfer of English occurs, giving the object ball some initial back spin. The transition from back spin to zero spin and forward spin of the object ball is lengthened, accounting for the appearance of skidding.

Byrne (in his first cited book) suggests that sweat, hair oil and grease from french fries could also increase the friction between balls. But most evidence indicates that these substances by themselves should reduce friction. It seems more likely that these foreign substances cause chalk to cling more strongly to a cue ball and last longer as the ball moves around the table.

Just what are the chances that a chalk mark will be present at the point of contact with an object ball? A quarter-inch mark covers 0.5 one percent of the surface of the ball. If the location of one chalk mark is random when two balls collide, the chance that the chalk mark is at the contact point is around 1 in 200. If other chalk marks remain from prior shots, more of the ball's surface is covered with chalk, and the odds for chalk at the contact point increase, perhaps to better than 1 in 100.

The greatest likelihood of skid occurring is expected when a succession

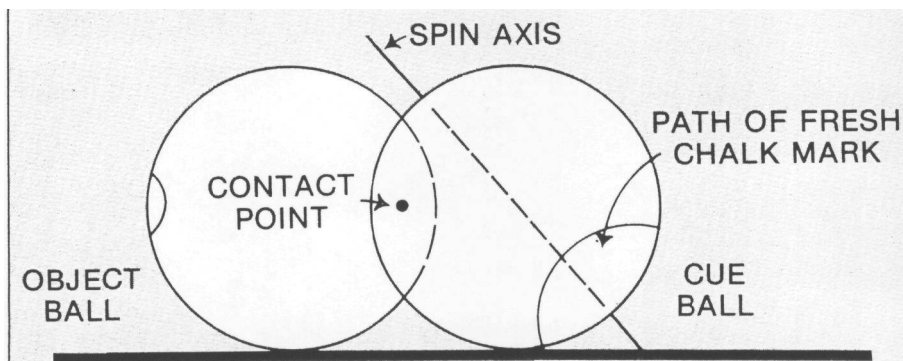

Figure 1: When the cue ball is struck with high-outside or low-inside English (relative to the object ball) there is no chance of the fresh chalk mark being at the contact point.

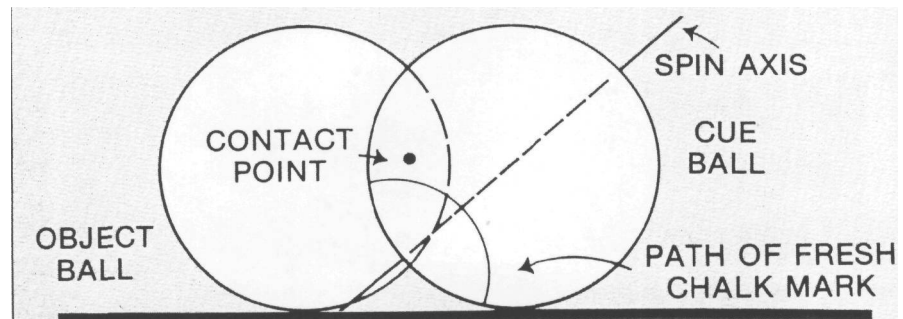

Figure 2: When the cue ball is struck with high-inside or low-outside, English, there is a chance for a fresh chalk mark to be at the contact point and causing undesired skid.

DOCTOR'S ORDERS

of shots are taken where the cue ball has traveled only short distances. This is because less chalk is rubbed off from previous shots, because the total distance traveled by the cue ball is smaller. This expectation seems to be confirmed by watching tournament tapes.

In shorter shots, the odds that a fresh chalk mark will be at the contact point with an object ball are much less random. The odds depend on how the cue ball spins as it moves toward the object ball. When the cue ball is shot without side spin, the fresh chalk mark cannot come into contact with the object ball for a cut angle greater than a few degrees. The forward or backward spin causes the chalk mark to remain located somewhere along a vertical circle around the center, oriented in the forward direction. The contact point lies to either side of this path and therefore cannot coincide with the location of the fresh chalk mark. Of course, an older mark could still cause a problem.

When a cue ball is sliding with side spin over a short ball-to-ball distance, the path of the chalk mark is a horizontal circle about the center. This gives it a chance to be at the contact point and cause skidding. It can be approximated (using advanced theory) that a cue ball with maximum side spin will complete half a revolution sideways over a distance of around 4 inches and one and a half revolutions over 12 inches. With less side spin, the distance for these particular revolutions become greater.

When a cue ball is struck high and outside (relative to the cut), it spins about an inclined axis, leaning toward

the side of the object ball (Fig. 1). The same axis inclination occurs when a ball is struck low and inside. A fresh chalk mark travels along a small circle, as illustrated in Fig. 1. We see that the fresh chalk mark cannot be present at the contact point. Thus, only an older chalk mark could possibly cause skidding for this type of shot.

When a cue ball is struck high and inside, or low and outside, the spin axis is inclined away from the side of the object ball (Fig. 2). The path of a fresh chalk mark is illustrated in Fig. 2. Depending on the angle of the cut and the amount of English applied, there is a chance that the fresh chalk mark would be located at the contact point between the balls.

While we have no control over where an older chalk mark will lie on a cue ball, we do have some control for fresh chalk marks, which are the most damaging. Summarizing the effects of spin, a fresh chalk mark will not contribute to skid when an object ball is cut if the cue ball has no side spin, if it is struck high and outside or if it is struck low and inside. Beware of shots where the ball is struck high and inside, low and outside, or when the cue ball slides with side English, since the possibility exists that the fresh chalk will cause skid.

In theory, the best preventive for the harm done by an older chalk mark is to clean the ball before each shot. But in a game, this would hardly be practical. It would slow the game down too much and would cause arguments over the ball placement in cases where a very small error in replacement could critically affect making a shot.

A number of practical precautions

could be instigated, however. Wiping the cue ball with a clean cloth at every practical opportunity would make sense. Possible opportunities include before each game and after each scratch when the ball is in hand. Also, perhaps in a refereed match, a player can request the cleaning of the cue ball where it lies. The referee would allow the request if he judges that a slight error in replacement of the ball is not critical to the next shot. Another important precaution, already carried out in some tournaments, is that balls should always be racked by referees wearing clean, white gloves. This would reduce placing moisture, oil or grease on the balls.

Two final precautions could also be taken. One is to wash all balls thoroughly before each day. The other is to use balls that are relatively new. This reduces the chances of a ball having a local rough spot, which would also cause increased friction between balls because of its roughness or because it readily collects chalk particles. If a ball with a damaged rough spot is found, it should be replaced.

The phenomenon of skid is perhaps the most unfortunate accident in pool. It occurs irrespective of the ability the player. It could lose a match for a player through no fault of his own. Currently, we just accept it as an unlucky incident that is part of the game. However, it still seems unfair if it is not the fault of the player. I believe that the precautions that I have mentioned should be given serious consideration for tournament play.

Dr. George Onoda is a research scientist at IBM and an avid pool and billiard player.



by Dr. George Onoda

Practicing Stun Shots

Simple geometry, using a semicircle, can help determine if you are executing stun shots properly.

A STOP SHOT occurs when the cue ball collides with an object ball head-on and has neither forward spin nor backward spin at the moment of contact. A stun shot is a cut shot having the identical cue-ball action as the stop shot. Because the cue ball in a stun shot has no forward or backward spin, its path after the carom is a straight line that is perpendicular to the object ball's path. I will refer to this cue ball path as the 90-degree path. As discussed often in previous articles in this magazine, the 90-degree path resulting from a stun shot serves as very useful reference for position play.

A stun shot is not easy to execute accurately for several reasons. It depends on three variables; the distance between the balls, the speed of the shot and the amount of initial back spin applied. It also requires adequate visualization of the 90-degree path.

Proper execution of stun shots requires practice. The stop shot should be mastered first, as it will provide a sense of the proper action needed for a stun shot. Then practice various drills with cut shots, such as those described in this article.

Because the stun shot involves a 90-degree angle, simple geometry can be used as guide for setting up shots to practice. A head or foot spot is equidistant to four pockets, two corner and two side pockets. Lines drawn from these pockets to the spot form 90-degree angles. So we can place the object ball on a spot and sink it into one of these pockets. If the cue ball falls in an adjacent pocket or comes close, we are applying stun action about as accurately as we can expect. For example, as illustrated in Diagram 1a, shooting the object ball into a corner pocket while sinking the cue ball in the other pocket indicates that the stun action is correct. The same can be said when the object ball is cut into the corner pocket as illustrated in Diagram 1b, and the cue ball falls in the side pocket.

We can extend this idea, through further use of geometry, to find other positions on a table that form 90-degree angles to two pockets. We use the properties of a semicircle, which is a half circle. From any point along the semicircle, two lines drawn to the end points of the semicircle are always at an angle of 90 degrees to each other. We can now imagine a semicircle extending from one pocket to another on a table and we place the

object ball on this semicircle. Then the lines from the ball to the two pockets are at 90 degrees to each other. The position of the cue ball when it strikes the object ball is slightly outside of the semicircle, but to a first approximation, we can suppose that it is essentially on the semicircle. Then when the object ball is sunk in one pocket and the cue ball falls in the other pocket, you are applying proper stun action. This method can be applied to two

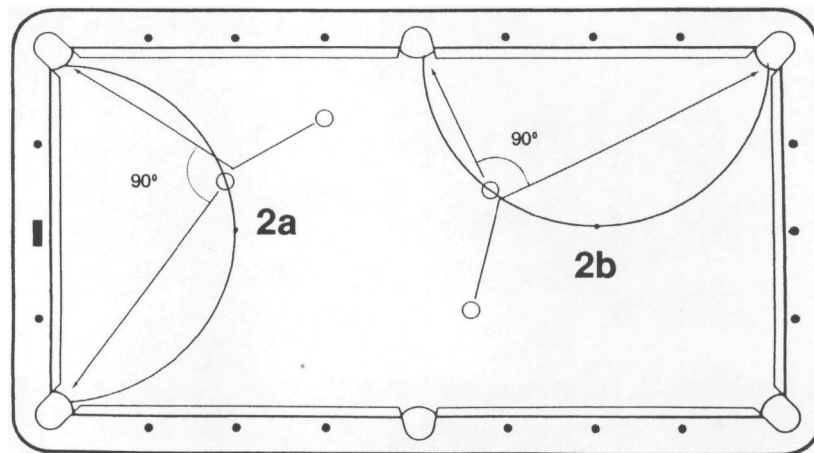
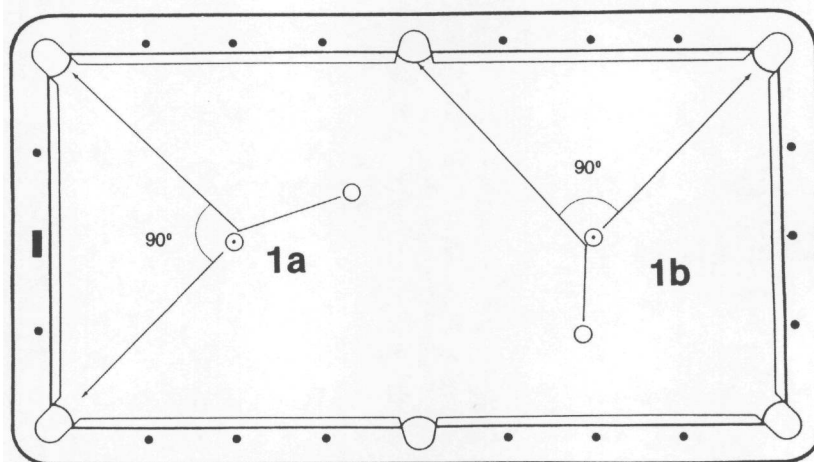

corner pockets (Diagram 2a), a corner pocket and an adjacent side pocket (Diagram 2b), two corner pockets along a long rail (Diagram 3), and two side pockets (Diagram 4). Whenever the object lies along one of these semicircles, a cue ball with stun action travels toward one pocket when the object ball is cut into the other pocket.

To use this method for practicing stun shot, place an object ball at a spot or along one of the semicircles. When

the object ball is pocketed, and the cue ball falls in the other pocket or comes close to it, you are properly executing stun shot. Practice with the different semicircles and with varying angles and distances between the cue ball and the object ball.

In the next article, it will be shown how the semicircle method can be applied in game situations.

Dr. George Onoda is a research scientist at IBM and an avid pool and billiard player.

